



Enebakkveien 117B, inngang H, 0680 OSLO
susanne@tidlosdesign.no
Tlf: 456 34 280

www.tidlosdesign.no

Skil ter



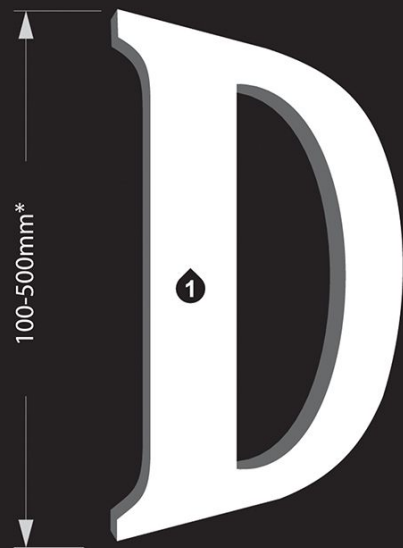

SKILT UTEN LYS

- 1 Aluminium 3-5 mm tykkelse
- 2 PMMA 3-30 mm tykkelse
- ! Anbefalt størrelse for skiltutførelse er målene du ser på siden av bokstaven

Profil 00

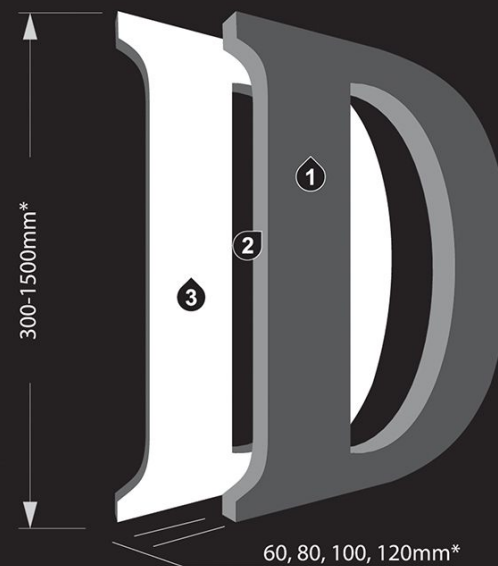

SKILT UTEN LYS

- 1 Aluminium 2 mm tykkelse
- 2 Aluminium 1 - 1,2 - 1,5 - 2 mm
- 3 PVC 10 mm
- ! Anbefalt størrelse for skiltutførelse er målene du ser på siden av bokstaven

Profil 01



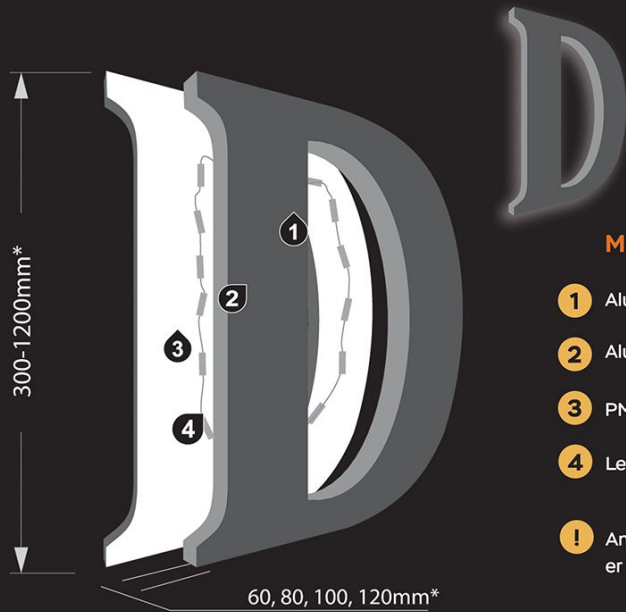

MED BAKGRUNNSBELYSNING

- 1 Aluminium 2 mm tykkelse
 - 2 Aluminium 1 - 1,2 mm
 - 3 PMMA, 8mm hvit
 - 4 Ledlys - dioder
- ! Anbefalt størrelse for skiltutførelse er målene du ser på siden av bokstaven

Profil 3

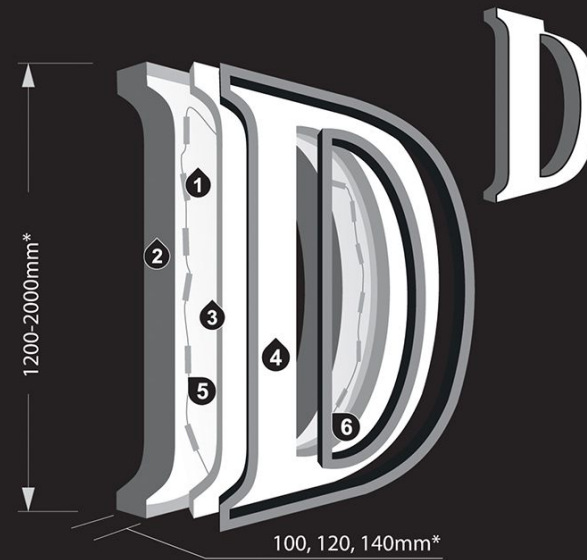

MED FRONTBELYSNING

- 1 Aluminium 2 mm tykkelse
 - 2 Aluminium 1 - 1,2 mm
 - 3 L-profiler i aluminium
 - 4 PMMA, 8mm hvit
 - 5 Ledlys - dioder
 - 6 L-profiler hjørner i aluminium
- ! Anbefalt størrelse for skiltutførelse er målene du ser på siden av bokstaven

Profil 4



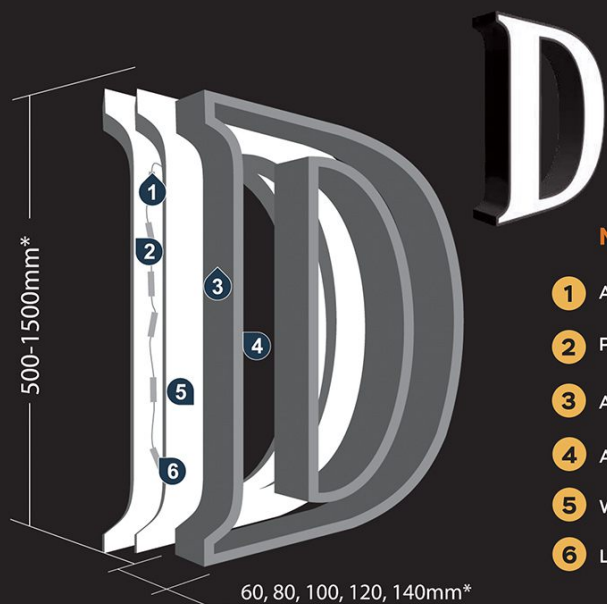

MED BAKGRUNNSBELYSNING

- 1 Aluminium 2 mm tykkelse
- 2 PVC 10x20mm kant
- 3 Aluminium 1 - 1,2 mm
- 4 Aluminium 2 mm tykkelse
- 5 WN 070 (PMMA) HVIT 3; 5mm
- 6 Ledlys - dioder

Profil 4D

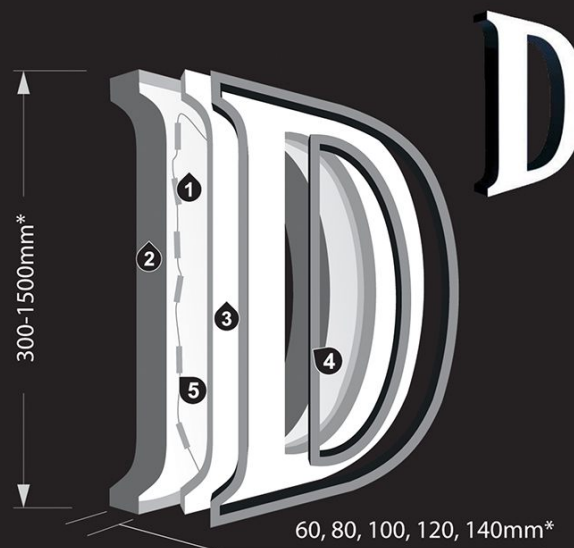

MED BAKGRUNNSBELYSNING

- 1 Aluminium 2 mm tykkelse
- 2 Aluminium 1 - 1,2 mm
- 3 AWN 070 (PMMA) HVIT 3 mm
- 4 "Elkamet" kant
- 5 Ledlys - dioder

Profil 05



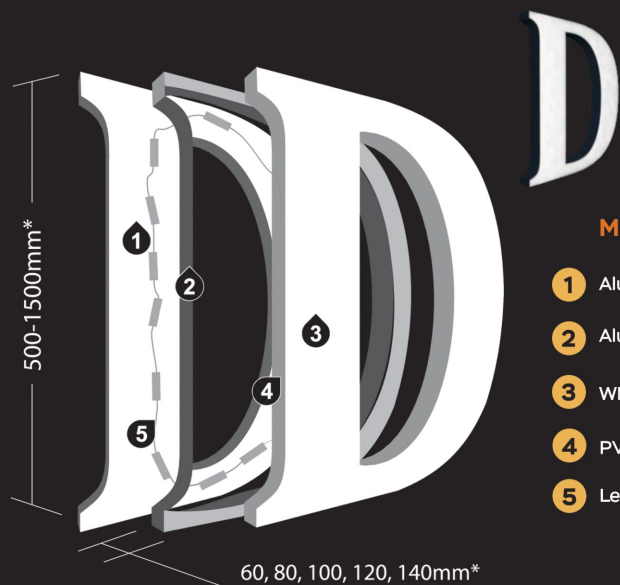

MED BAKGRUNNSBELYSNING

- 1 Aluminium 2 mm tykkelse
- 2 Aluminium 1; 1,2; 1,5mm
- 3 WN 070(PMMA) HVIT 3; 5mm
- 4 PVC 3; 5mm kant
- 5 Ledlys - dioder

60, 80, 100, 120, 140mm*

Profil 5S

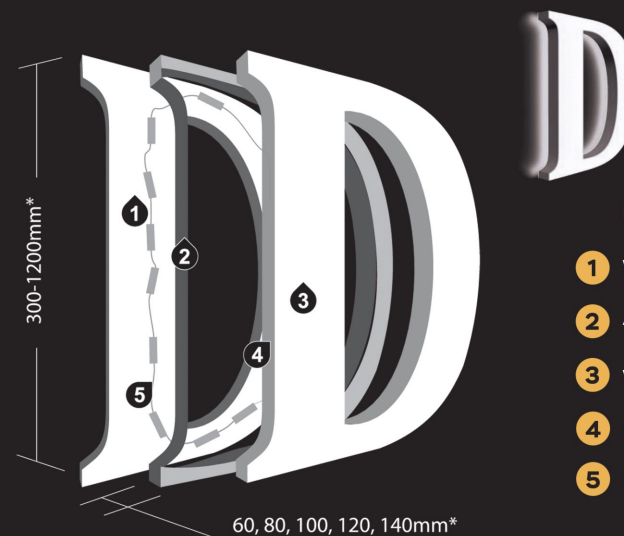

MED BAKGRUNNSBELYSNING

- 1 WN 770(PMMA) HVIT 8mm
- 2 Aluminium 1; 1,2mm
- 3 WN 070(PMMA) HVIT 3; 5mm
- 4 PVC 3 kant
- 5 Ledlys - dioder

60, 80, 100, 120, 140mm*

Profil 5S+3



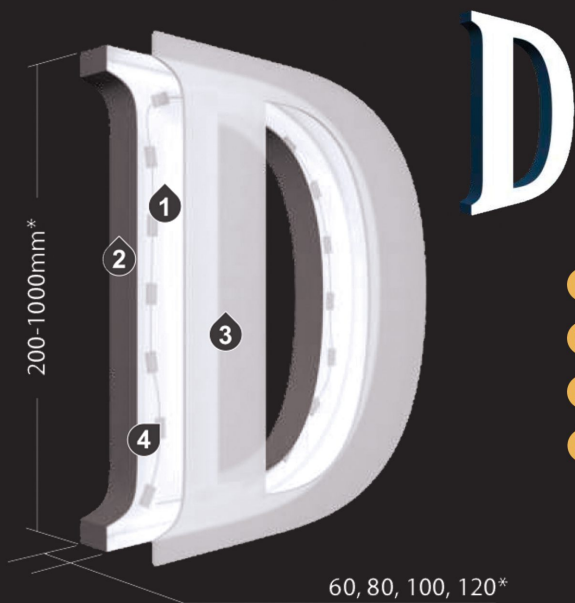

MED BAKGRUNNSBELYSNING

- 1 Aluminium 2 mm tykkelse
- 2 Aluminium 1 mm tykkelse
- 3 WN 770(PMMA) HVIT 8mm
- 4 Ledlys - dioder

Profil 6

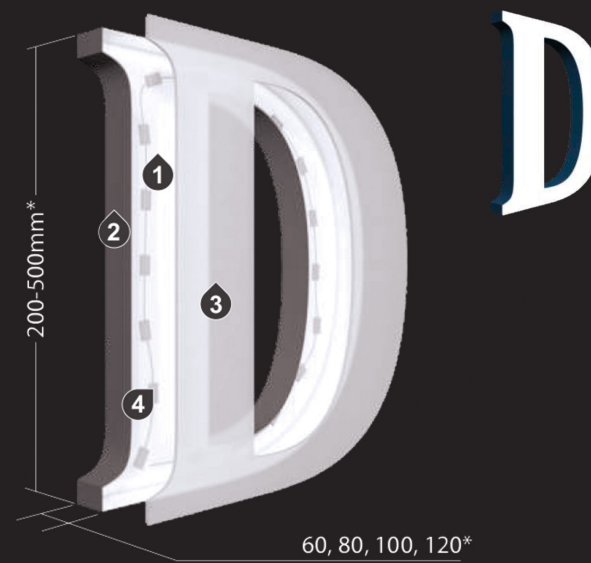

MED BAKGRUNNSBELYSNING

- 1 PVC 10mm
- 2 Aluminium 0,7 mm tykkelse
- 3 WN 770(PMMA) HVIT 5mm
- 4 Ledlys - dioder

Profil 6D





MED BAKGRUNNSBELYSNING

- 1 Aluminium 1 mm tykkelse
- 2 WN 770(PMMA) WHITE 8mm;
WN 070(PMMA) WHITE 3; 5mm
- 3 Ledlys - dioder

60, 80, 100, 120, 140mm*

Profil 6+3

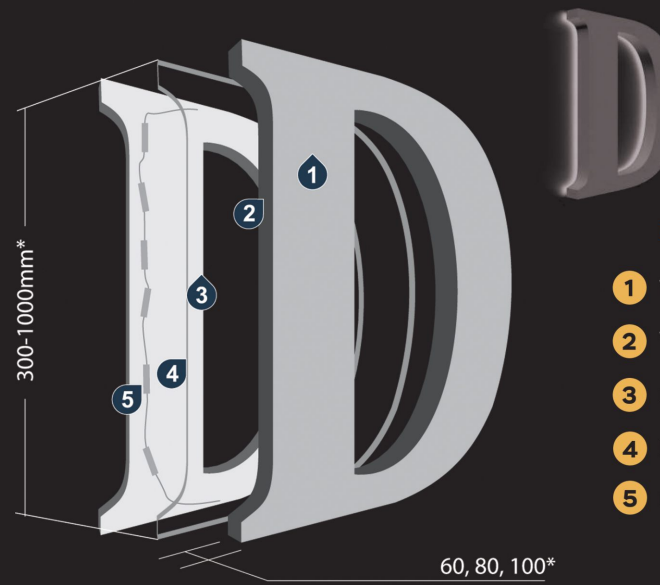

MED BAKGRUNNSBELYSNING

- 1 WN 070(PMMA) HVIT 3; 4; 5mm
- 2 WN 070(PMMA) HVIT 2mm
- 3 PVC 10mm
- 4 PVC 3; 5mm kant
- 5 Ledlys - dioder

60, 80, 100*

Profil 8



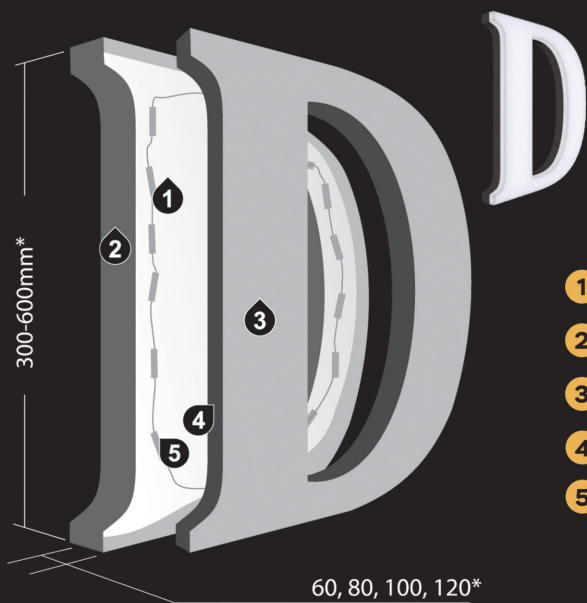

MED BAKGRUNNSBELYSNING

- 1 Luminium 2 mm tykkelse
- 2 Luminium 1 mm tykkelse
- 3 WN 070(PMMA) CLEAR 3mm
- 4 WN 070(PMMA) HVIT 2mm
- 5 Ledlys - dioder

Profil 8D



MED BAKGRUNNSBELYSNING

- 1 PVC 10mm
- 2 Luminium 1 mm tykkelse
- 3 Luminium 2 mm tykkelse
- 4 WN 770(PMMA) HVIT 8mm
- 5 WN 070(PMMA) CLEAR 3; 4mm
- 6 Ledlys - dioder

Profil 10





MED BAGGRUNNSBELYSNING

- 1 PVC 10mm
- 2 Aluminium 1 mm tykkelse
- 3 Aluminium 2 mm tykkelse
- 4 WN 070(PMMA) CLEAR 3; 4mm
- 5 (PMMA) HVIT 8-20mm
- 6 Ledlys - dioder

Profil H10

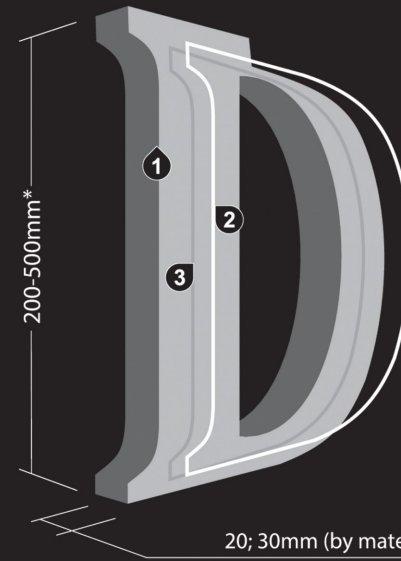

MED BAGGRUNNSBELYSNING

- 1 Acrylic HVIT 30; 20 mm
- 2 LED tape
- 3 Lim fyll

P30 - All sides shines
 P30F - Front lightning
 P30FB - Front, back lightning
 P30FS - Front, side lightning
 P30B - back lightning
 P-30BS - Back, side lightning

Profil 30 (20)



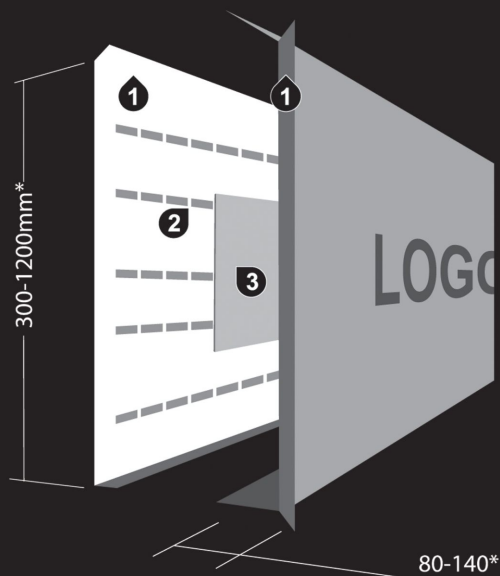

- 1** Brettet aluminium 2mm tykelse
- 2** WN 070 (PMMA) HVIT 3mm
- 3** Ledlys - dioder

Profil L1

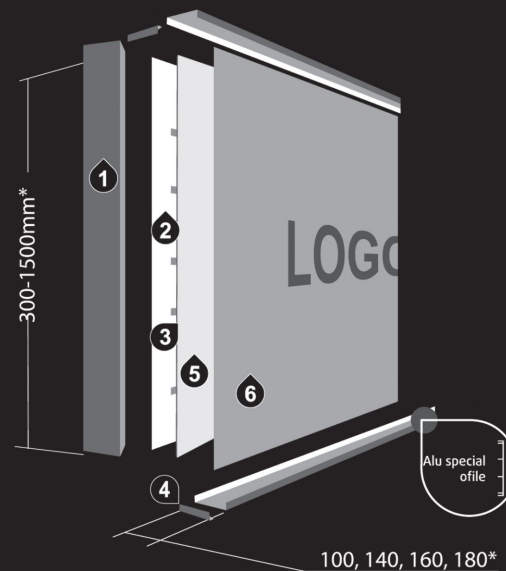

- 1** Spesial aluminium profil
- 2** Aluminium 2mm (Dibond) 3mm
- 3** Ledlys - dioder
- 4** Aluminium L profil
- 5** PMMA 3, 5mm
- 6** Film

Boksen er mulig å bytte da siden er byttbar

Profil L4

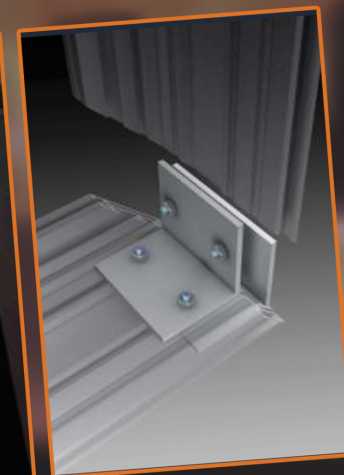

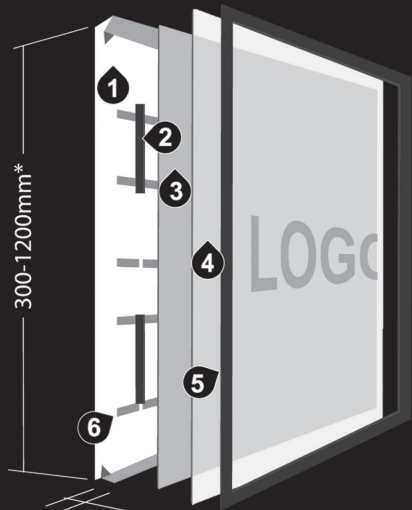

- 1 Brettet aluminium 2mm tykelse
- 2 Aluminium L profil
- 3 WN 070 (PMMA) HVIT 3, 5 mm
- 4 Film
- 5 Aluminium L profil
- 6 Ledlys - dioder

60-180*

Profil L4s

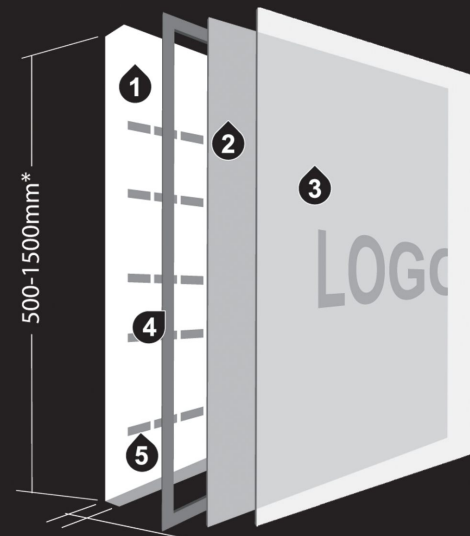

- 1 Brettet aluminium 2mm tykelse
- 2 WN 070 (PMMA) HVIT 3, 5 mm
- 3 Film
- 4 PVC 3, 5mm kant
- 5 Ledlys - dioder

60-160*

Profil L5s

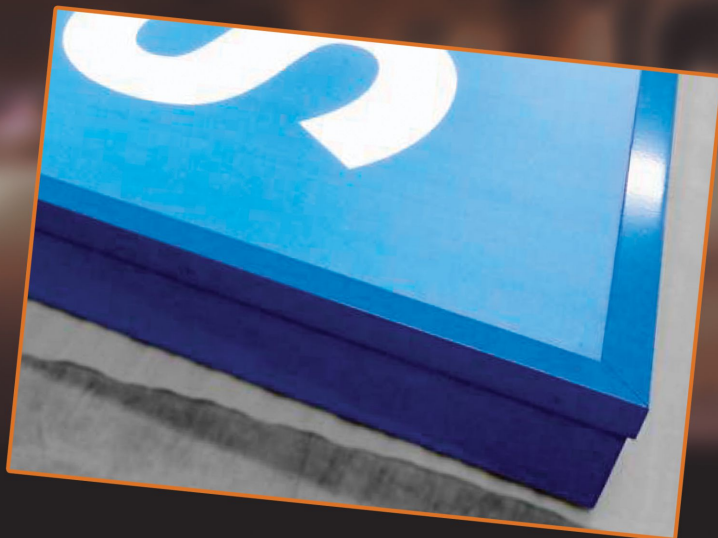

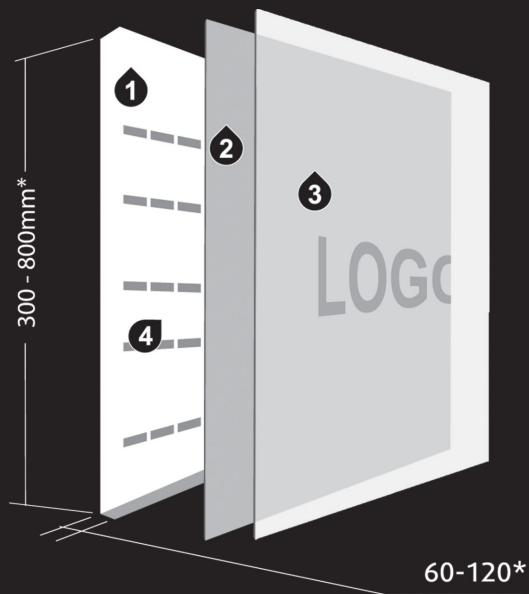

- 1 Brettet aluminium 2mm tykelse
- 2 WN 770 (PMMA) HVIT 8 mm
- 3 Film
- 4 Ledlys - dioder

Profil L6

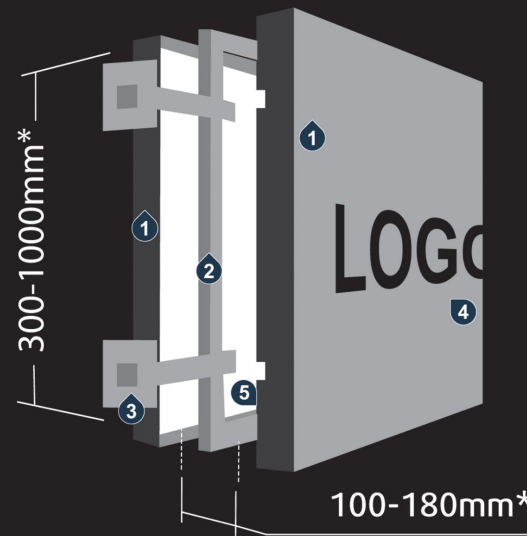

- 1 Brettet aluminium 2mm tykelse
- 2 Aluminiumsramme
- 3 Monteringssokkel (Aluminium 8 mm plate)
- 4 WN 770 (PMMA) HVIT 8 mm
- 5 Ledlys - dioder

Profil DS (Dobbelsidig)

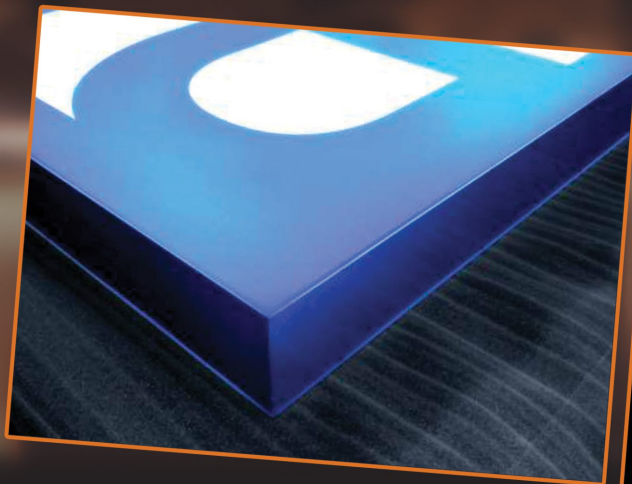

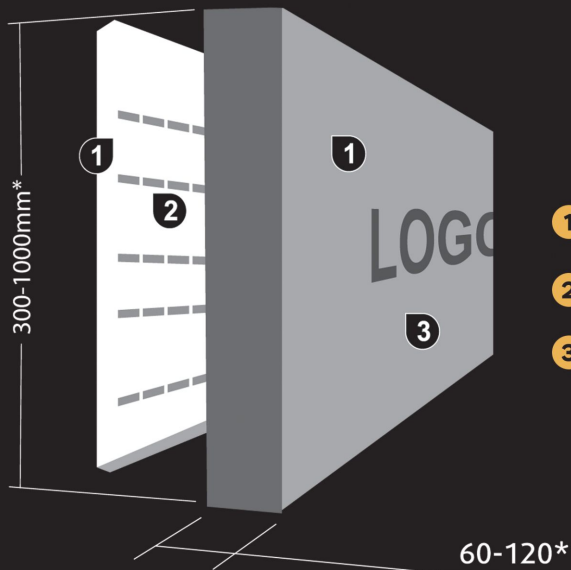

- 1 Brettet aluminium 2mm tykkelse
- 2 Ledlys - dioder
- 3 WN 770 (PMMA) HVIT 8 mm

Profil L10

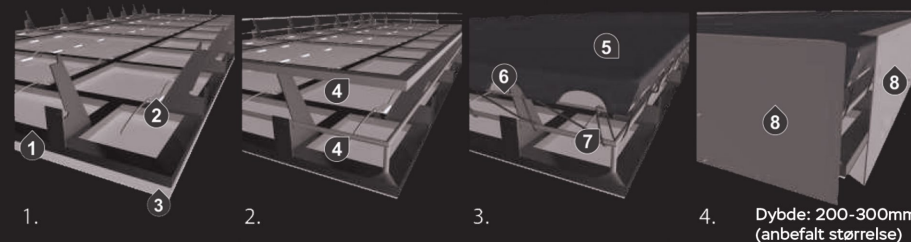

- 1 Ramme
- 2 Ledlys - dioder
- 3 Bunn Dibond 3 mm
- 4 Fleks ansikter strekke rammer
- 5 Fleks ansikt
- 6 Fleks ansikter innenfor rammen
- 7 D 10mm stang
- 8 Sider 2mm aluminium

Profil FFS

